

# 19" CSRD TF - MESH 2 DECAL - SCALE 1:1

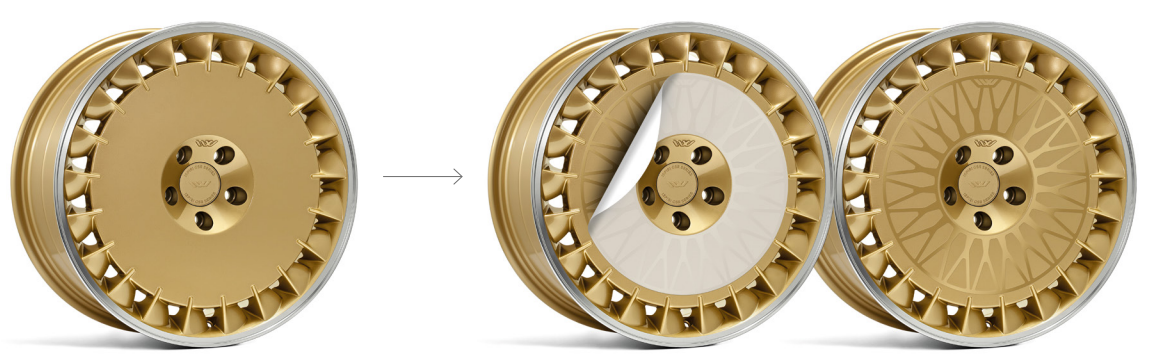

Available to buy from Ispiri, cut from sign vinyl for extra durability. Alternatively take this template to a vehicle wrapping specialist to create your own. Ispiri accept no responsibility for decals produced by a 3rd party.

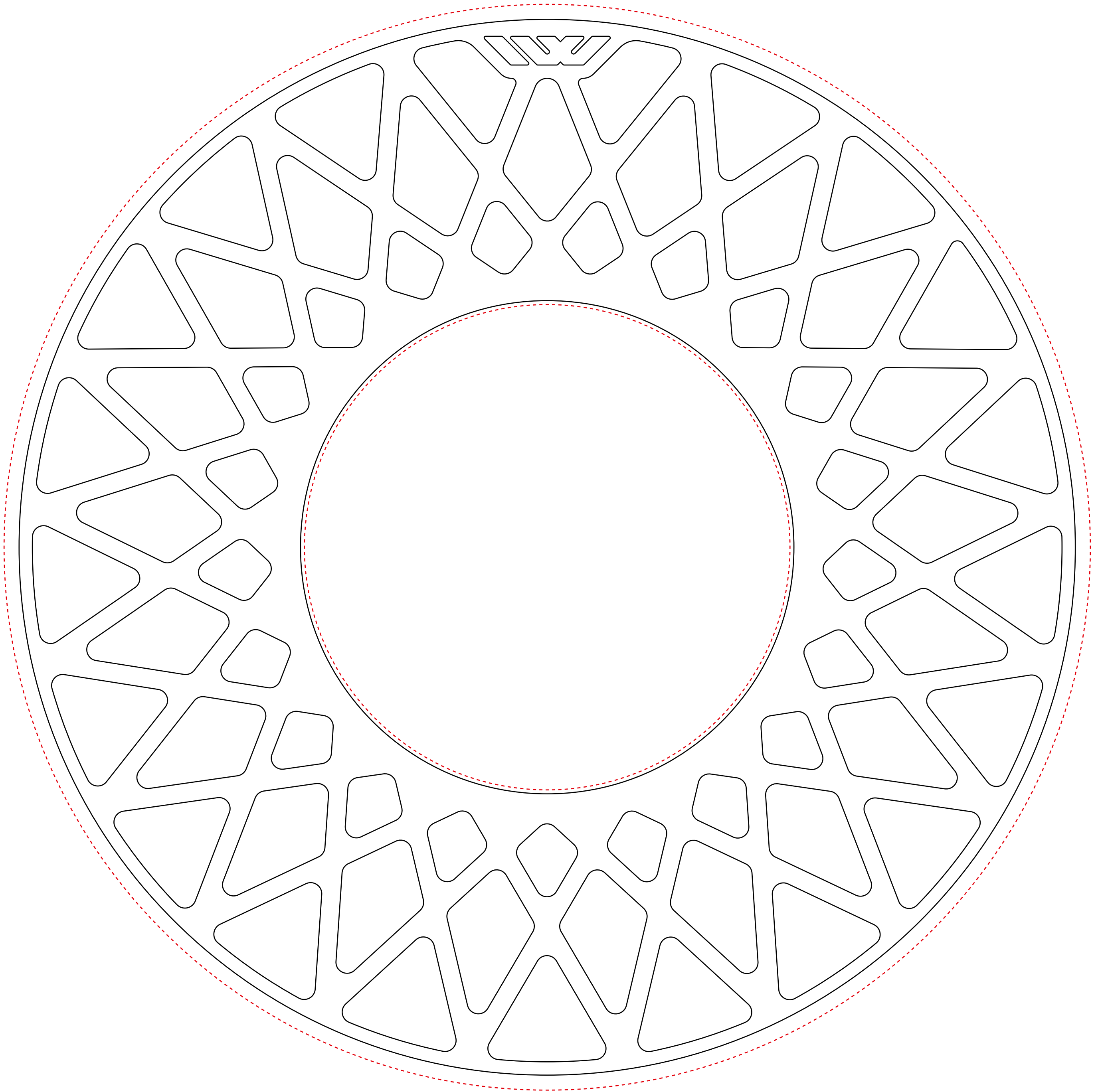

### DECAL TEMPLATE

For ease of application cut decal backing paper to create a ring shaped template [marked by dotted lines above].



### ACTUAL PRINT SIZE

Do not alter decal graphic in any way!

## DECAL POSITION

Match decal positioning to reference below. Use the IW logo embossed on the wheel as a vertical guide.

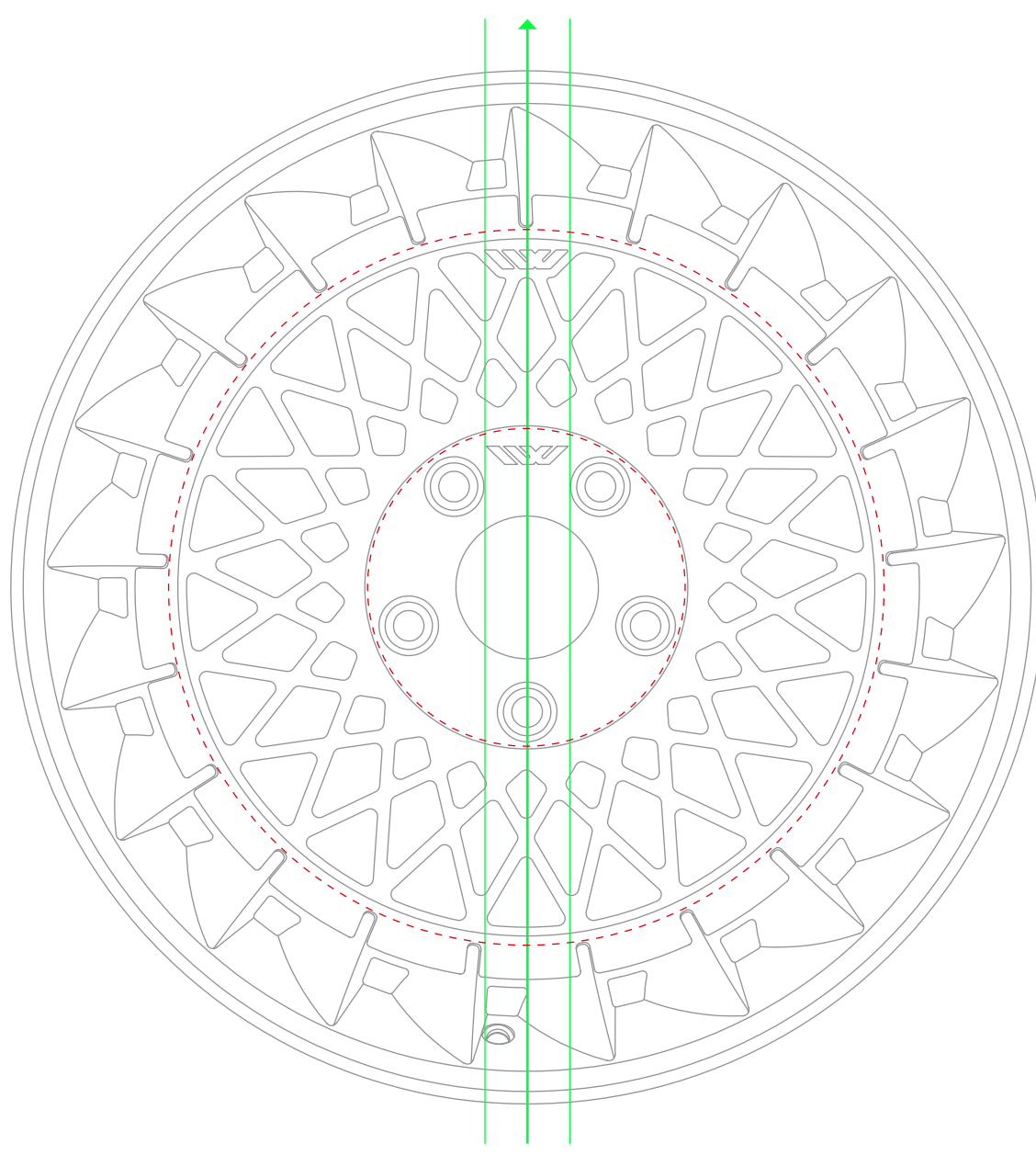

### CORRECT DECAL POSITION

## COLOUR OPTIONS

Below are vinyl colour combinations we prefer, use these as a guide or create your own.

### VINTAGE GOLD VINYL COLOURS

Matt Gold vinyl

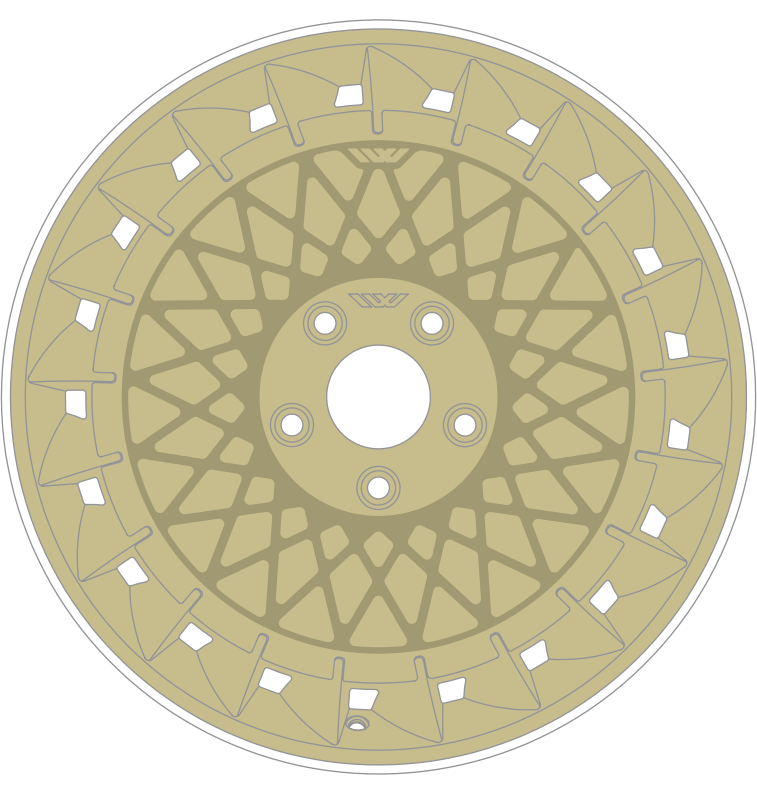

Matt White vinyl

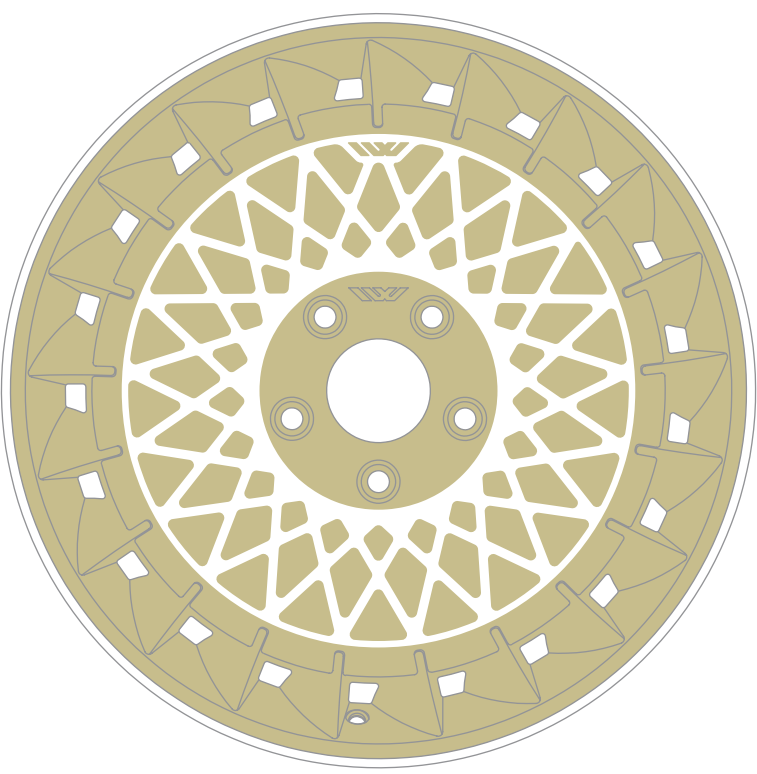

Matt Silver vinyl

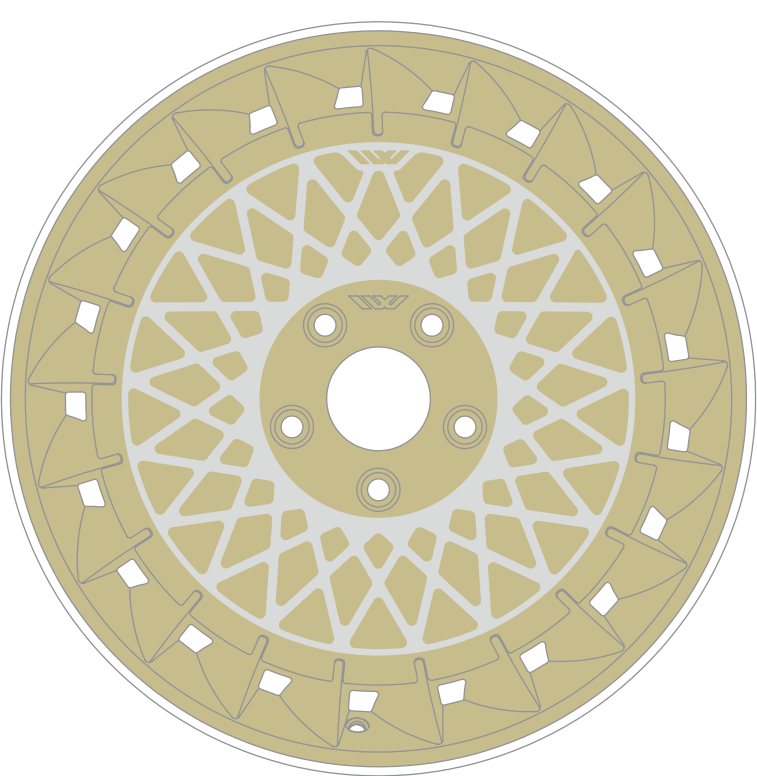

### CARBON GRAPHITE VINYL COLOURS

Matt Black vinyl

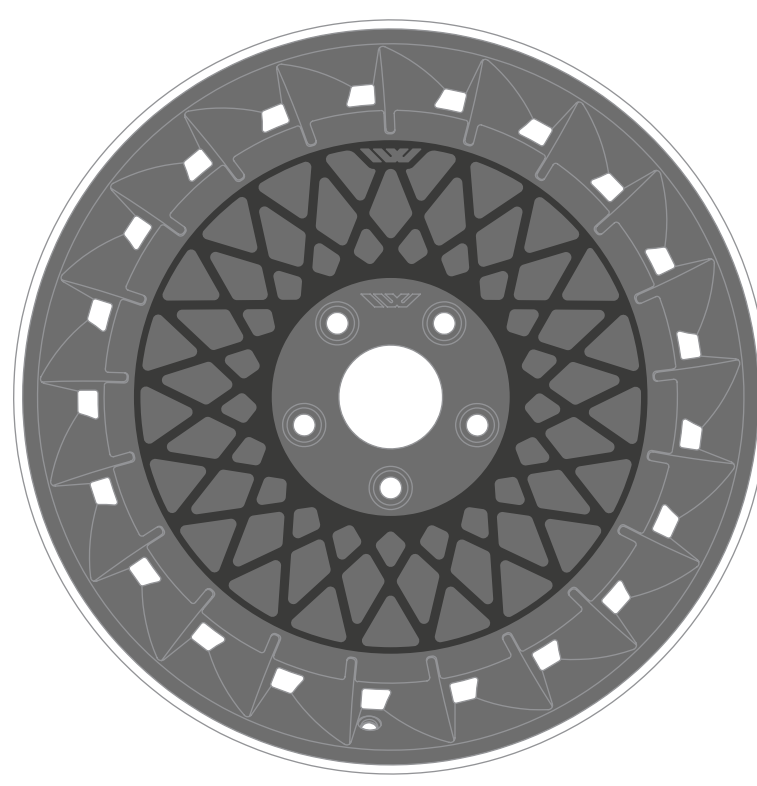

Matt White vinyl

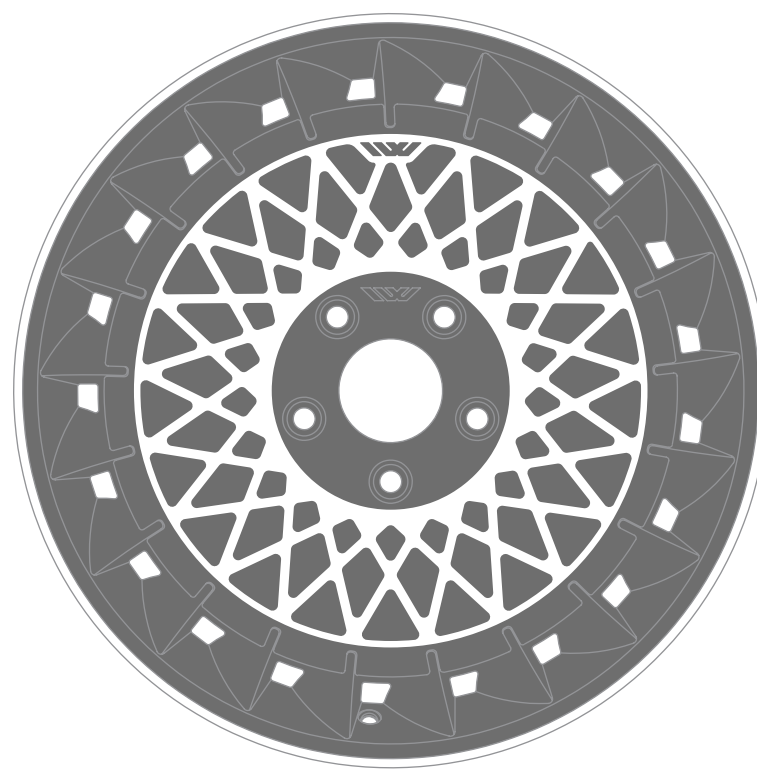

Matt Silver vinyl

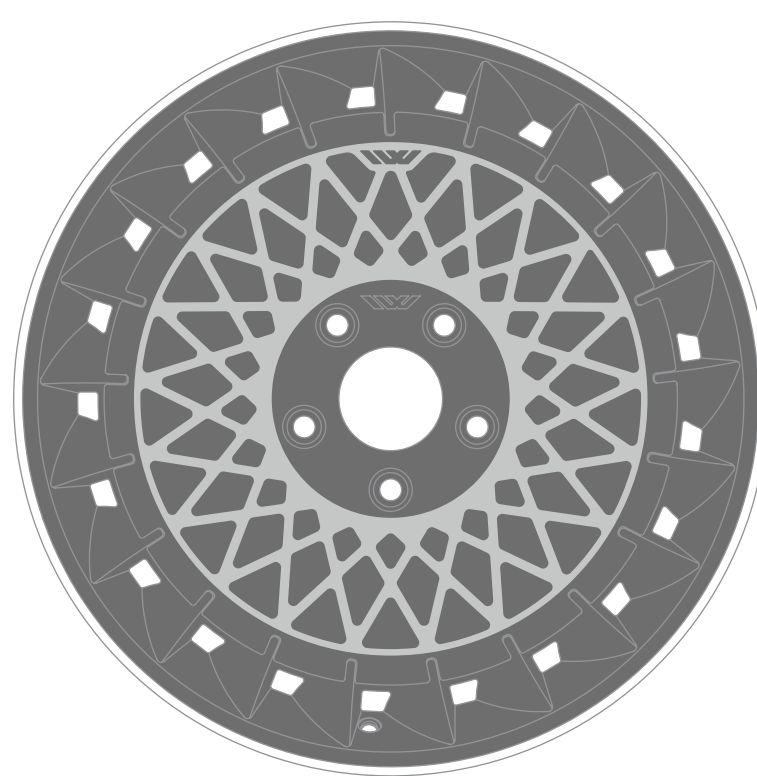

## FURTHER CONSIDERATIONS

- Use sign vinyl for extra durability.
- Use a vehicle wrapping specialist to produce and install.
- Fit decals prior to wheels being mounted.

